

Instruction Sheet

Subject: FilterQuick Front Disposal Kit 8263323

Models affected: FilterQuick Gas Fryers with BULK OIL

In Kit 8263323		
Part Number	Description	Qty
8068867SP	WAND ASSY, FPG18FB OIL DISCARD	1
1086011SP	DISPOSAL ASSY,FQ GAS FRONT	1
8090412	SCRW,#10-1/2 HX WSHR HD NP	8
8158000	LOCTITE	1
8130062	ELBOW,1/2 90DEG BM	1
8130087	NIPPLE,1/2NPT X 1 1/2 BM	1
8197321	INSTRUCTIONS	1
8197206	FILTERQUICK CONTROLLER INSTRUCTIONS	1

Follow these instructions to add front disposal to a FilterQuick fryer.

1. Remove power from fryer and external electrical connections.
2. Remove from hood to gain access to the back.
3. Remove the fryer lower back.
4. Attach new front dispose assembly using supplied screws (see Figure 1 for location of assembly. Location of screws depicted by arrows).

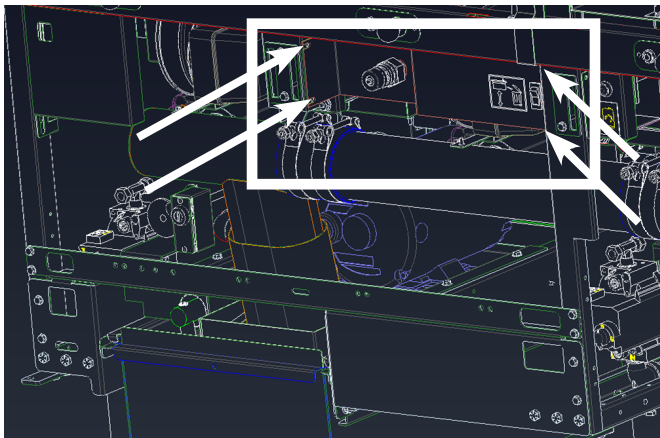

Figure 1

5. Locate the rear waste assembly switch on the waste oil handle assembly, to the left of the filter pump.
6. Disconnect the black wire from the rear waste assembly switch (see Figure 2).

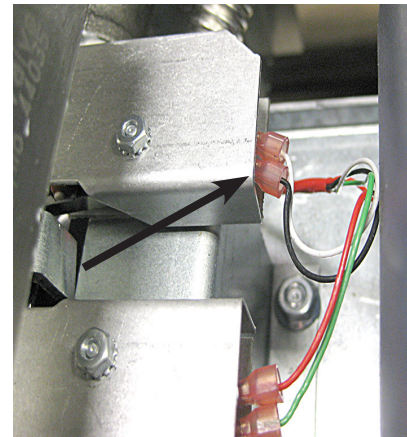
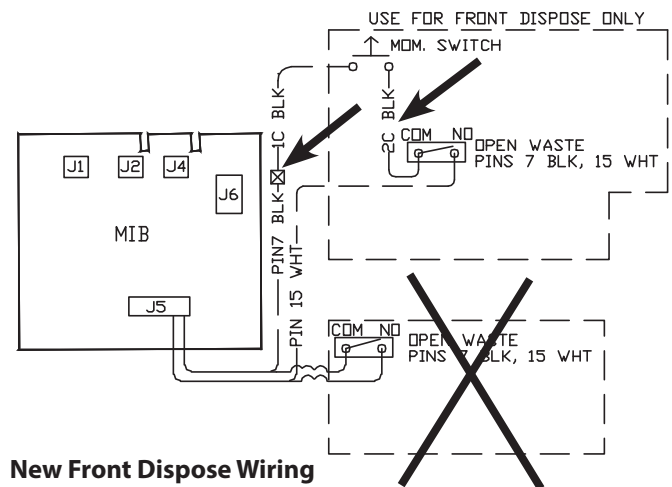

Figure 2

7. Locate the black wire with the male terminal on the new assembly harness and connect to the black wire that was disconnected in step 6 (see Figure 3).
8. Locate the black wire with the female terminal on the new assembly harness and plug into open terminal on the switch in step 6 (see Figure 3).



New Front Dispose Wiring

Figure 3

9. From the rear of the fryer, remove and discard the flexline indicated with the X (see Figure 4) between the waste assembly manifold and the bulk waste connection on the rear of the fryer.

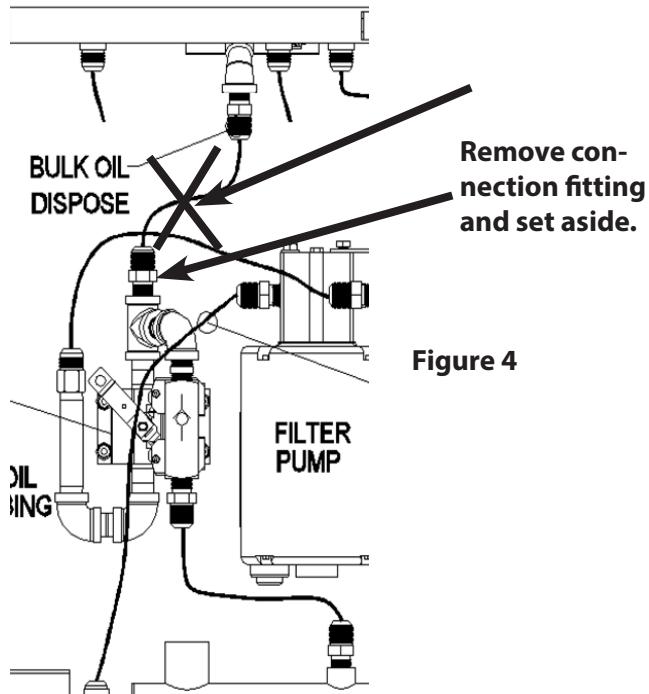

Figure 4

Old Plumbing (Remove and discard flexline shown by X)

10. Remove the flexline connection fitting shown in Figure 4 from the waste assembly and set aside.
11. Attach the supplied 1/2" x 1-1/2" nipple to T-fitting where fitting was removed in previous step (see Figure 5). Use supplied Loctite on fittings.

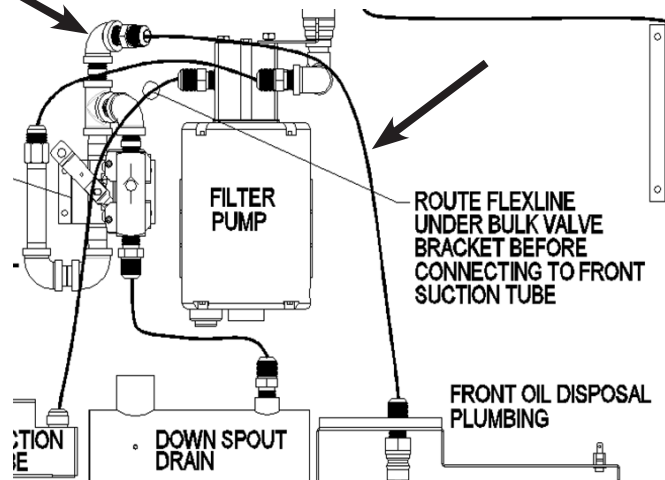

Figure 5

12. Attach the supplied 1/2" 90 degree elbow the nipple attached in the previous step (see Figure 5). Use supplied Loctite on fittings.
13. Attach the flexline connection fitting removed in step 10 to the 90 degree elbow attached in the previous step (see Figure 5). Use supplied Loctite on fittings.

14. Attach the flexline from the new front disposal assembly to the flexline connection attached in the previous step (see Figure 5).
15. Reattach lower rear back.
16. Plug in any external electrical connections.
17. Re-position the fryer under the hood.
18. Allow the fryer to completely boot up until all controllers displays OFF.
19. On the far left most controller press and hold the ✓ checkmark button until the controller scrolls Info Mode, changing to MAIN MENU and then PRODUCT SETUP.
20. Press ▶ to scroll to VAT SETUP and press ✓.
21. Enter 1656.
22. The controller displays SYSTEM.
23. Press ✓.
24. Press ▶ to scroll to WASTE and press ▲. The right display changes to FRONT.
25. Press ▶ to scroll to EXIT and press ✓.
26. All controllers reboot.
27. Cycle the control power using the hidden reset momentary rocker switch under the left control box in gas (see Figure 6) or behind the right control box over the JIB in electric (see Figure 7). HOLD THE SWITCH FOR 15 SECONDS ENSURING THE MIB BOARD HAS POWERED FULLY DOWN.

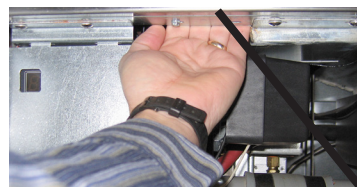

Figure 6

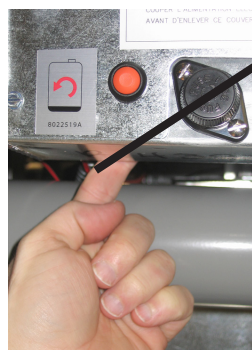

Figure 7

28. Attach the supplied wand to the quick disconnect on the new front disposal assembly and test using the procedures in the following steps. NOTE: Pump the oil back into the vat when testing.
29. Press the FILTER button until FILTER MENU is displayed for three seconds changing to FILTER.
30. Follow the steps in section 1.9.4 on page 1-15 of the supplied manual 8197206.